

FURUNO

Installation Manual
RADAR SENSOR
Model **DRS4D-NXT**

(Product Name: SOLID STATE DOPPLER RADAR)

SAFETY INSTRUCTIONS i
SYSTEM CONFIGURATION iii
EQUIPMENT LISTS iv
FOREWORD v

1. INSTALLATION 1
1.1 Installation Considerations 1
1.2 Installation of the Radar Sensor 3
1.3 Wiring 7

2. INITIAL SETUP 8
2.1 Check Points After Installation 8
2.2 Initial Setup 8

3. MAINTENANCE, TROUBLE- SHOOTING 15
3.1 Maintenance 15
3.2 Replacement of Fuse 15
3.3 Troubleshooting 16
3.4 Life of Parts 16

APPENDIX 1 RADIO REGULATORY INFORMATION AP-1

SPECIFICATIONS SP-1
PACKING LISTS A-1
OUTLINE DRAWING D-1
INTERCONNECTION DIAGRAM S-1

NXT



 **FURUNO ELECTRIC CO., LTD.**

www.furuno.com

All brand and product names are trademarks, registered trademarks or service marks of their respective holders.



SAFETY INSTRUCTIONS

The installer of the equipment must read the safety instructions before attempting to install the equipment.



WARNING

Indicates a potentially hazardous situation which, if not avoided, could result in death or serious injury.



CAUTION

Indicates a potentially hazardous situation which, if not avoided, can result in minor or moderate injury.



Warning, Caution



Prohibitive Action



Mandatory Action



WARNING



ELECTRICAL SHOCK HAZARD Do not open the equipment.

The installation does not require you to open the radar sensor.



Do not disassemble or modify the equipment.

Fire, electrical shock or serious injury can result.



Wear a safety belt and hard hat when working on the antenna unit.

Serious injury or death can result if someone falls from the radar mast.



Be sure the power source is compatible with the voltage rating of the equipment.

Connection of an incorrect power source can cause fire or damage the equipment.



WARNING



Turn off the power at the power source before beginning the installation.

Fire, electrical shock or serious injury can result if the power is left on or is applied while the equipment is being installed.









Use the proper fuse.

Use of a wrong fuse can damage the equipment or cause fire.



Do not depend one navigation device for the navigation of the vessel.

For the safety of vessel and crew, the navigator must check all aids available to confirm position.

 WARNING		 CAUTION													
 <p>The radar antenna emits electromagnetic radio frequency (RF) energy which can be harmful, particularly to your eyes. Never look directly into the antenna aperture from a close distance while the radar is in operation or expose yourself to the transmitting antenna at a close distance.</p> <p>Distances at which RF radiation levels of 100, 50 and 10 W/m² exist are given in the table below.</p> <table border="1" style="width: 100%; border-collapse: collapse; text-align: center;"> <thead> <tr> <th>Model</th> <th>100W/m²</th> <th>50W/m²</th> <th>10W/m²</th> </tr> </thead> <tbody> <tr> <td>DRS4D-NXT</td> <td>N/A</td> <td>N/A</td> <td>0.7 m</td> </tr> </tbody> </table>		Model	100W/m ²	50W/m ²	10W/m ²	DRS4D-NXT	N/A	N/A	0.7 m	 <p>Ground the equipment to prevent mutual interference.</p>  <p>Observe the following compass safe distances to prevent interference to a magnetic compass.</p> <table border="1" style="width: 100%; border-collapse: collapse; text-align: center;"> <thead> <tr> <th>Standard compass</th> <th>Steering compass</th> </tr> </thead> <tbody> <tr> <td>0.55 m</td> <td>0.30 m</td> </tr> </tbody> </table>  <p>It is recommended that you connect the sensor to a disconnecting device (circuit breaker, etc.) to control the power.</p>		Standard compass	Steering compass	0.55 m	0.30 m
Model	100W/m ²	50W/m ²	10W/m ²												
DRS4D-NXT	N/A	N/A	0.7 m												
Standard compass	Steering compass														
0.55 m	0.30 m														

WARNING LABEL

A warning label is attached to the antenna unit. Do not remove the label. If the label is missing or damaged, contact your dealer about replacement.

 WARNING 	 警告 
To avoid electrical shock, do not remove cover. No user-serviceable parts inside.	感電の恐れあり。サービスマン以外の方はカバーを開けないで下さい。内部には高電圧部分が多い数多くあり、万一さわると危険です。

Name: Warning Label (2)
 Type: 03-129-1001-3
 Code No: 100-236-743

SYSTEM CONFIGURATION

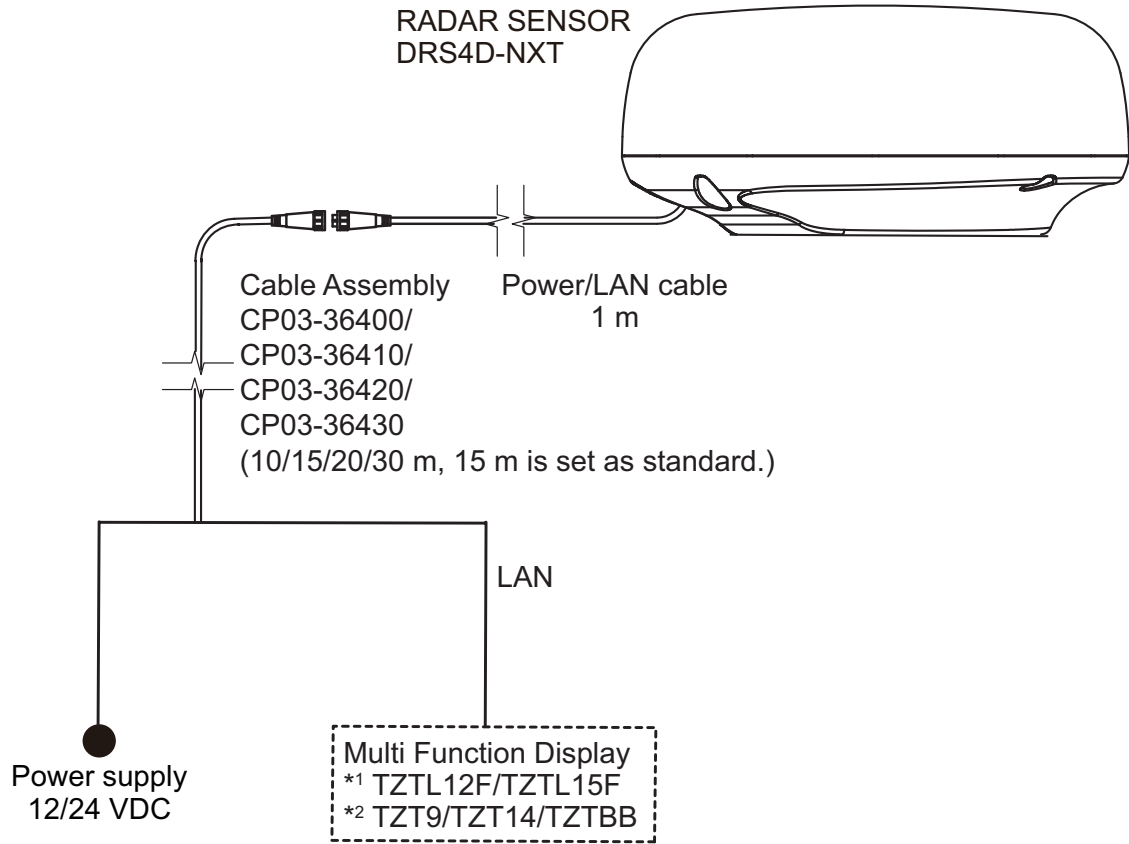

—— : Standard supply

----- : Local supply

*1 Software upgrade to version 3.01 (to be released in Spring 2016) or later is required.

*2 Software upgrade to version 5.01 or later is required.

EQUIPMENT LISTS

Standard supply

Name	Type	Code No.	Qty	Remarks
Radars Sensor	RSB-135-115	000-029-247	1	
Installation Materials	CP03-37001	001-426-200	1	
	CP03-36400	000-027-211	Select one	Cable Assembly, 10 m
	CP03-36410	000-027-212		Cable Assembly, 15 m
	CP03-36420	000-027-213		Cable Assembly, 20 m
	CP03-36430	000-027-214		Cable Assembly, 30 m
Spare Parts	SP03-18101	001-426-190	1	Fuses

Optional supply

Name	Type	Code No.	Qty	Remarks
Radome Mount	OP03-208	001-078-340	1	
Retrofit Kit	OP03-239	001-426-250	1	For DRS2D, DRS4D and DRS6A
LAN Cable	MOD-Z072-020+	001-167-880-10	1	2m
LAN Cable	MOD-Z072-050+	001-167-890-10	1	5m
LAN Cable	MOD-Z072-100+	001-167-900-10	1	10m
Joint Box	TL-CAT-012	000-167-140-10	1	For LAN cable extension

*: After wiring is completed, waterproofing of LAN connector is required. Wrap the connector with vinyl tape.

FOREWORD

General Information about DRS4D-NXT

- TARGET ANALYZER* function displays targets which is moving and getting close to own ship in red and other targets in different colors. Speed analyzing range is ± 50 kn.
* Requires a GPS sensor. When you change the setting of [Target Analyzer Mode] to [Rain], rain clutter is displayed.
- AUTO TARGET ACQUIRE function automatically acquires only the targets which are moving and getting close to own ship within the range of 3 NM by Doppler calculation. Automatic Doppler function will be activated when there is a target which approaches own ship with the speed of over 3 kn.
* The judged speed of target is dependent on its vector towards own ship.
- RezBoost provides azimuth resolution equivalent to comparable open-array radar.
Note: Refer to the Operator's Manual for your Multi Function Display regarding the above new functions.
- Instant ON function. This radar sensor does not have a magnetron, therefore preheating of the magnetron is unnecessary.
- Reduced electricity emission means no need to worry about the radiation hazard.
- Magnetron-less radar means no periodic replacement of magnetron or related parts.
- Retrofit from DRS2D, DRS4D or DRS6A is available using the existing cable.
Refer to the following document, supplied with the optional kit OP03-239: "Retrofit Procedures for DRS4D-NXT (Type; C32-01501-x/Code no.; 000-191-116-xx).
- RACON (RADar beaCON) and SART (Search And Rescue Transponder) within 0.5 to 1.5 NM (Range dependant) can be displayed.
* The signal from RACON and SART is shown as a line.
- The maximum display range is 36 NM in the signal range mode.
- ARPA (Automatic Radar Plotting Aid) function applicable range is 12 NM.
* ARPA symbols are erased when switching between signal and dual range modes and vice versa.
- Dual Range Mode has the following limitations.
 - The maximum display range is 12 NM. (36 NM when single display)
 - The maximum detection range is reduced a maximum of 20% compared to the single display.

Progran No.

- 0359360-01.**
** denotes minor modifications.

CE Declaration

- With regards to CE declarations, please refer to our website (www.furuno.com), for further information about RoHS conformity declarations.

1. INSTALLATION

1.1 Installation Considerations

NOTICE

Do not apply paint, anti-corrosive sealant or contact spray to coating or plastic parts of the equipment.

Those items contain organic solvents that can damage coating and plastic parts, especially plastic connectors.

- Do not paint the radome, radar wave emission may be affected.
- Do not select a location that allows water to accumulate at the base of the sensor.
- Do not cut power/LAN cable or cable assembly when installing.
- Do not block air vent at the bottom of radome.

Connect to a distribution switchboard

- The radar sensor has no power switch. Therefore, it is recommended that you connect the sensor to a distribution switchboard with a switch for power control.

Considerations for selecting a location for installation

- Install the radar sensor on radar arch, on a mast or on an appropriate platform. For sailboats, a “radome mount” is optionally available for installing the sensor to a mast.
- This radar sensor emits a horizontal (360°) and a vertical (25°) beam.

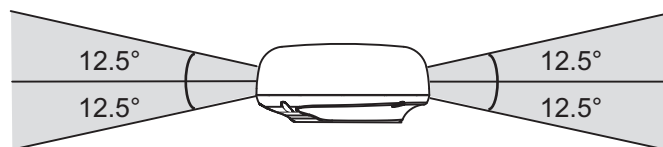

Place the sensor where there is a good all-round view with, as far as possible, no part of the ship's superstructure or rigging intercepting the scanning beam. Any small obstruction causes not only shadows and blind sectors, but also the deterioration of antenna ability, such as beam width and side-lobe level. It also reduces the radar's functionality, for example azimuth resolution, and can cause false echoes. A mast for instance, with a diameter considerably less than the horizontal beam width of the radiator, causes only a small blind sector, but a horizontal spreader or cross trees in the same horizontal plane as the radar sensor would be a much more serious obstruction; you would need to place the radar sensor well above or below it. Be sure there are no metallic objects near the antenna. See illustrations on the following page for typical placement on a sailboat and powerboat.

- Install the radar where large structures, such as a mast, will not be within 1 m diameter from the center of radar.
- Select a location free of structures as much as possible, so as not to cause a blind sector. A blind sector within the radar beam may prevent proper display of radar echoes.

1. INSTALLATION

- It is rarely possible to place the radar sensor where a completely clear view in all directions is available. Thus, you should determine the angular width and relative bearing of any shadow sectors for their influence on the radar at the first opportunity after installation.

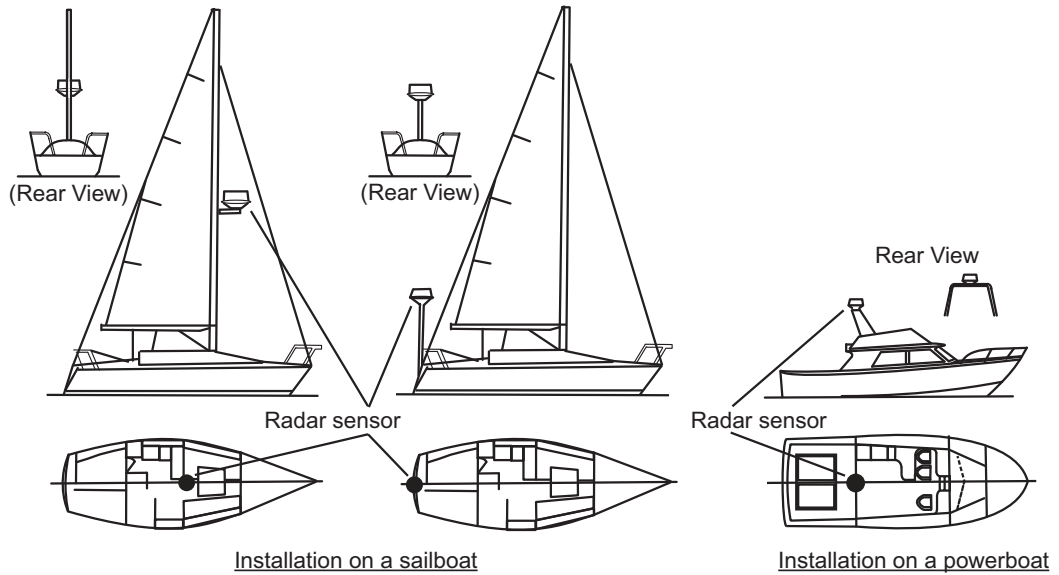

Typical installation on a sailboat and power boat

- The radar sensor should not be operated or stored in any position other than the proper operational position (upright).

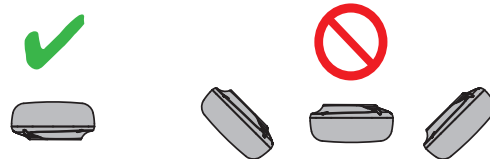

Consideration for selecting a location for installation (multiple radars)

- In case multiple radars are installed on a ship, DO NOT install the DRS4D-NXT within the range of beam area emitted from other radar(s). Use the illustration below for reference when selecting a suitable location for installation. The SSD inside the RS4D-NXT will be damaged if it is within the radar beam emission area from other radar.

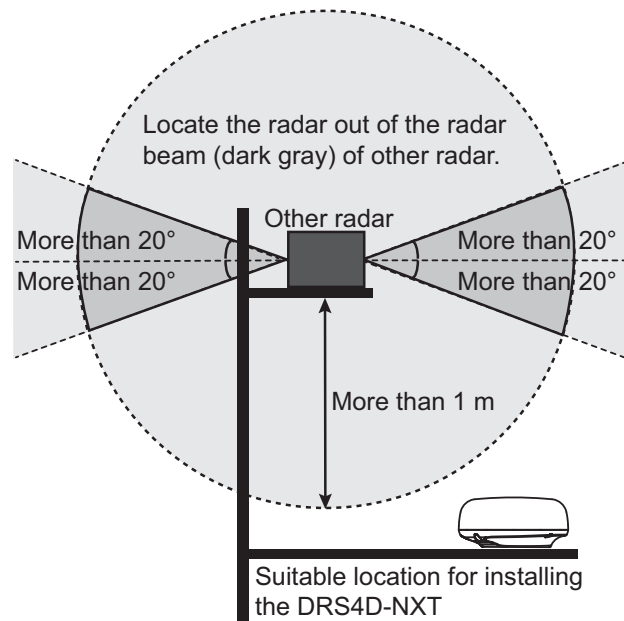

Installation with the radiotelephone equipment

- Install the radome away from radiocommunication antennas (SSB, VHF, Inmarsat) and GPS antenna to prevent radar interference.
- Install the radome away from the radiotelephone equipment so that electrical noise does not affect the radiotelephone equipment.

Cable routing

- In order to reduce the chance of picking up electrical interference, avoid, where possible, routing the power/LAN cable and cable assembly near other electrical equipment on-board. Also, avoid running the cable in parallel with other electrical cables.
- Make sure that the power/LAN cable and cable assembly do not run horizontally and it is placed away from the cables carrying radio signal and antennas.

For large vessels

- When this radar sensor is to be installed on a large vessel, consider the following points:
 - The length of the pre-attached power/LAN cable is 1 m from radome to the connector.
 - The length of the standard supply cable assembly is 15 m from the connector to the power supply and display.
 - The power/LAN cable which runs between the radar sensor, power supply and display comes in lengths of 10 m, 15 m, 20 m or 30 m. Select the length when purchasing.
 - Deposits and fumes from a funnel or other exhaust vent can adversely affect the aerial performance and hot gases may distort the radiator portion. The radar sensor must not be mounted where the temperature is more than 55°C (131°F).

1.2 Installation of the Radar Sensor

Determine the suitability of the mounting location **BEFORE** permanently mounting the sensor. Incoming and outgoing signals may overlap one another depending on the shape of the vessel, preventing communication between the radar and display. Set the sensor on the selected location and connect the sensor to the distribution switchboard and display unit. Turn on the sensor and the display unit. Check that the picture is updated with each sweep on the display unit. Some trial and error may be necessary to find a suitable location.

Required tools for installation

Prepare the tools shown to the right.

- A wrench for M10 bolts
- An electric drill with $\phi 11$ mm (0.43") drill bit

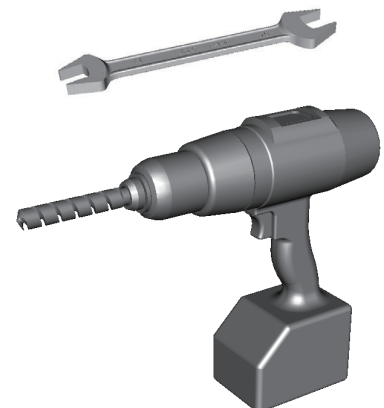

1. INSTALLATION

Installation on a platform

There are 5 steps necessary to install the radar sensor. The illustration below summarizes the installation.

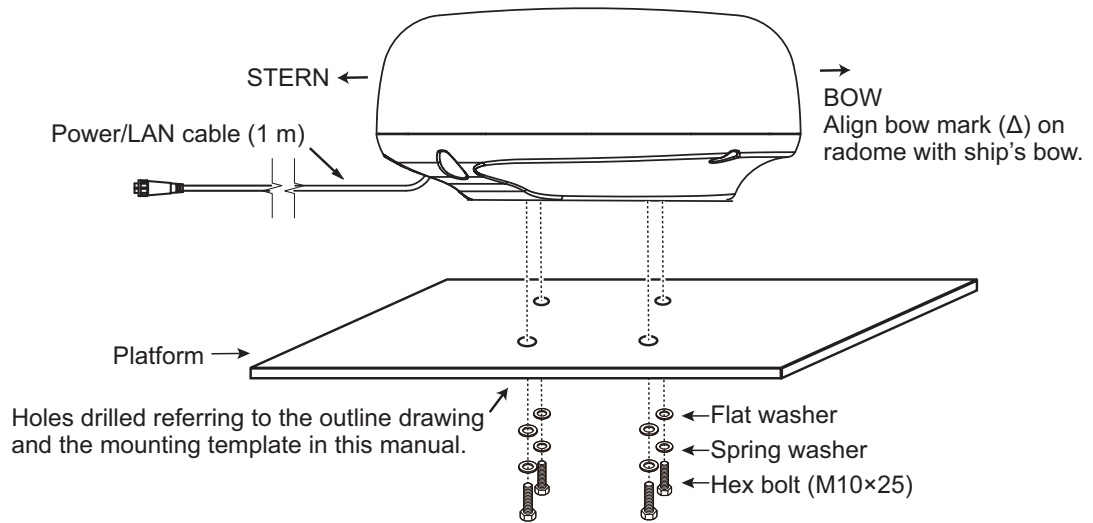

1. Set the supplied mounting template to the mounting location, then drill four fixing holes in the mounting location.

Note: The holes must be parallel with the fore and aft line.

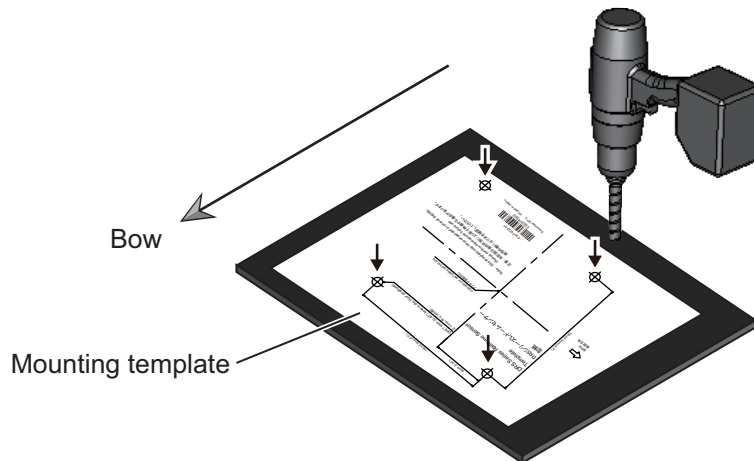

2. Put the radar sensor on the platform with the bow mark (Δ) on the sensor aligned with the ship's bow.
3. Use hex bolts (see the table below for bolt length), flat washers and spring washers to secure the radar sensor to the platform. The torque for the bolts is 19.6 to 24.5 N•m.

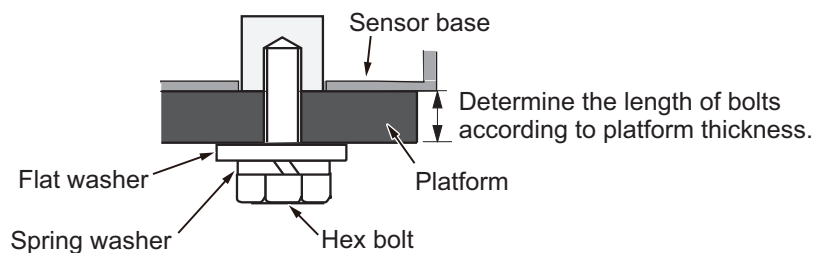

Platform thickness and bolt to use

Platform thickness	Size of bolts to use
6 - 10 mm	M10x25 (Supplied)

Platform thickness	Size of bolts to use
Over 10 mm	Local supply

4. Connect the power/LAN cable to the cable assembly.

Follow these guidelines for laying the power/LAN cable

- The connectors must not strike any part of the vessel due to wind, etc.
- Do not apply any load to the connectors.
- If the cable is passed through a mast on a sailboat, be sure the cable does not touch ropes (sheet, halyard, etc.).
- Do not let the cable touch the hull.
- The cable must be located where no tension is applied to the connectors. To prevent tension, create a loop in the cable close to the sensor and tie the loop with cable ties, as in the figure below.

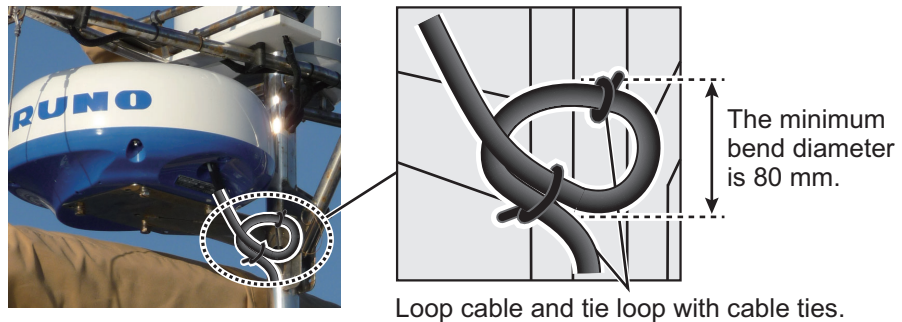

- Wrap the junction of the connectors with self-vulcanizing tape for waterproofing.

1) Wrap the junction of the connectors with one layer of self-vulcanizing tape.

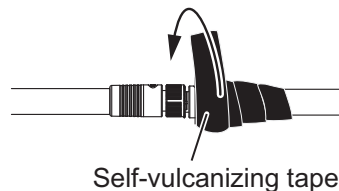

2) Change wrap direction and wrap one layer of the self-vulcanizing tape again.

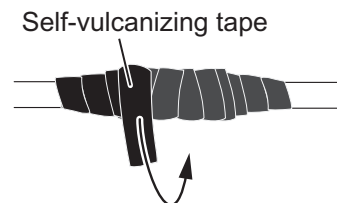

3) Wrap one layer of the vinyl tape over the self-vulcanizing tape.

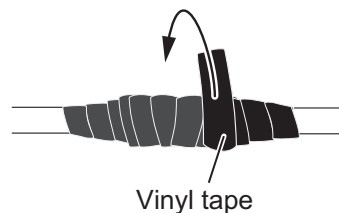

4) Change wrap direction and wrap one layer of the vinyl tape again.

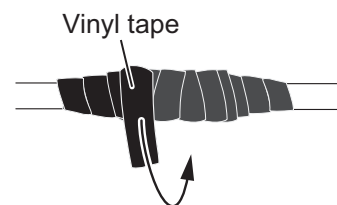

- Fasten the cable to the mast, etc. at the neck of each connector with a cable tie.
- Make loops with surplus cable.

5. Connect the cable assembly to the power source and display unit.

1. INSTALLATION

Installation with the radome mount

The optional radome mount lets you fasten the radar sensor to a mast on a sailboat.

Name, Type: Radome Mount, OP03-208

Code No.: 001-078-340

Name	Type	Code No.	Qty
Mounting plate	03-018-9001-0	100-206-740-10	1
Support plate (1)	03-018-9002-3	100-206-753-10	1
Support plate (2)	03-018-9003-3	100-206-763-10	1
Fixing plate	03-018-9004-3	100-206-773-10	2
Bracket (1)	03-018-9005-0	100-206-780-10	1
Bracket (2)	03-018-9006-0	100-206-790-10	1
Hex bolt w/washer	M8×20 SUS304	000-162-955-10	10
Hex bolt w/washer	M4×12 SUS304	000-162-956-10	4

How to assemble the bracket

1. Fasten the fixing plates to brackets (1) and (2) with four M8×20 hex bolts.
2. Fit brackets (1) and (2) loosely with support plates (1) and (2) using four M4×12 hex bolts, so that the gap between the brackets can be adjusted.
3. Place the mounting plate on the bracket and fix it loosely with four M8×20 hex bolts.

How to fasten the bracket to the mast

1. Drill eight holes of 6.5 mm diameter in the mast and fix the bracket with eight stainless steel rivets (local supply) of 6.4 mm diameter.
2. Fasten the bolts (M8 × 20) on the bracket.
3. Fasten the radar sensor to the bracket.

Connect the power cable to the power source, observing the guidelines for laying the power cable shown on this page.

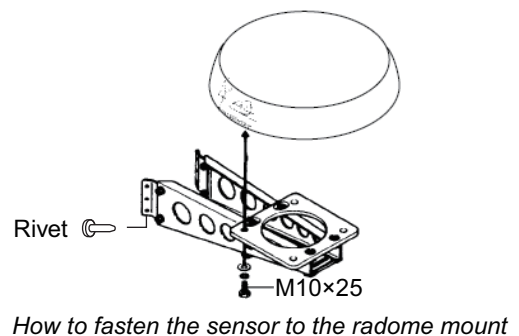
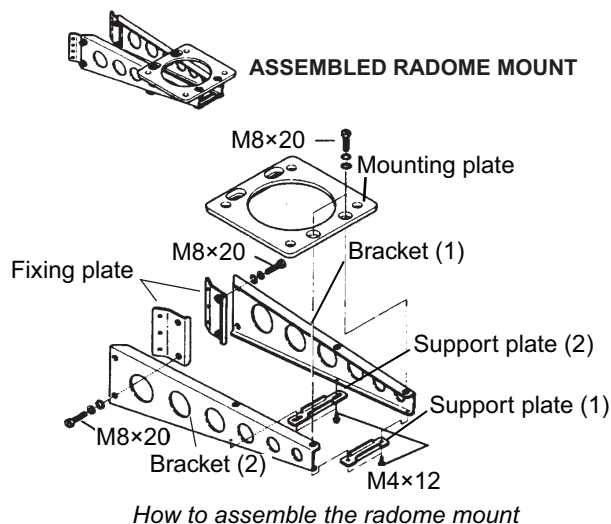

1.3 Wiring

1.3.1 Power requirement

The DRS4D-NXT requires either 12 VDC or 24 VDC power. Connect the red cable to the positive terminal of ship's battery; the blue cable to the negative terminal. The black cable is a shielding cable for grounding.

1.3.2 Network cable connection

Connect the network cable to the multi function display device*. *Hereafter TZTL12F, TZTL15F, TZT9, TZT14 and TZTBB are referred to as "multi function display device".

2. INITIAL SETUP

2.1 Check Points After Installation

Before using the product, carry out the following:

- Mechanical checks
- Turning the power on and initial setup

Mechanical checks

Check below points before switching on the DRS4D-NXT.

- All washers are in place and bolts are fully fastened.
- All connections are secure and network cable is connected to the multi function display device.
- All connecting cables and wires are secured as instructed on page 4.

Turning the power on and initial setup

Use the information in this manual and the manual for multi function display device to power the sensor and to proceed with initial setup.

1. Ensure that all personnel are clear of the antenna.
2. Press and hold down the power key of your multi function display device until the unit is ON.
3. Take the appropriate action on your multi function display device to turn on the DRS4D-NXT.
4. Check if the heading is correctly aligned - targets should appear at their correct bearing relative to the boat's bow. Adjust the alignment if necessary, referring to section 2.2.

2.2 Initial Setup

Turn on the multi function display device, and do the initial setup for the antenna unit.

2.2.1 Initial setup for NavNet TZtouch2 (TZTL12F/TZTL15F)

1. Tap the [Home] icon to show the home screen and display mode settings.
2. Tap [Radar] from the [Settings] menu.
3. Tap [Radar Source], then select the appropriate antenna unit.

Note: If an antenna unit is connected but does not appear in the [Radar Source] list, close the list and open it again. The name of the antenna unit should appear with a check mark, as in the example below.

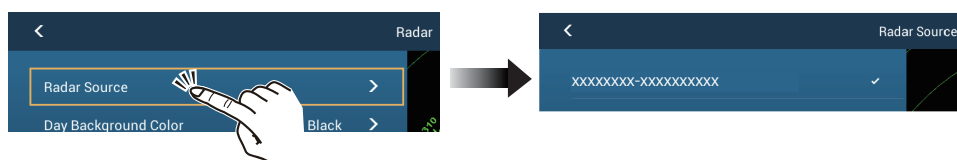

4. Drag the [Radar] menu display to show the menu item [Radar Initial Setup], then tap [Radar Initial Setup].
5. Referring to the tables below, set up the radar.

[Radar] menu - [Radar Initial Setup]

Menu item	Description
[Antenna Rotation]	Select the speed of antenna rotation.
[Antenna Heading Align]	See "How to align the antenna heading" on page 9.
[Main Bang Suppression]	If main bang appears at the screen center, slide the circle icon so that the main bang disappears, while watching the radar echo at the left-hand side of the display.
[Enable Sector Blanking]	Up to two sectors may be selected for blanking (no transmission). Select [ON] to enable this feature. Set the start and end angles (0° to 359°).
[Enable Sector 2 Blanking]	

[Radar] menu - [Antenna Position]

Menu item	Description
[Longitudinal (from bow)] [Lateral (-Port)]	Referring to the figure on the right, enter the radar antenna positioning bow-stern (Longitudinal) and port-starboard (Lateral) position from the origin. 
[Antenna Height]	Select the height of the antenna above the waterline.
[Radar Monitoring]	Display various information regarding the connected radar.
[TX Channel]	Select [1], [2] or [3], the channel where the interference is smallest.
[Target Analyzer Mode]	You can emphasize rain clutter or target echoes when the target analyzer is active. Select [Rain] or [Target] as appropriate.
[Auto acquire by Doppler]	When selecting [ON], approaching targets (ships, rain clutter, etc.) within 3 NM from own ship are automatically acquired by the Doppler calculated from the radar echo.
[Set Hardware To Factory Default]	Resets the radar selected at [Radar Source] to factory default.
[Reset Default Settings]	Resets [Radar] menu settings to default.

How to align the antenna heading

You have mounted the antenna unit facing straight ahead in the direction of the bow. Therefore, a small but conspicuous target dead ahead visually should appear on the heading line (zero degrees).

In practice, you will probably observe some small bearing error on the display because of the difficulty in achieving accurate initial positioning of the antenna unit. The following adjustment will compensate for the error.

2. INITIAL SETUP

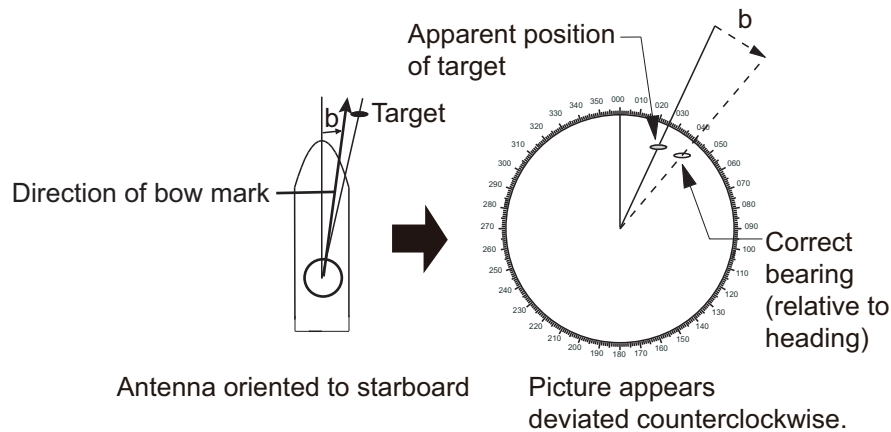
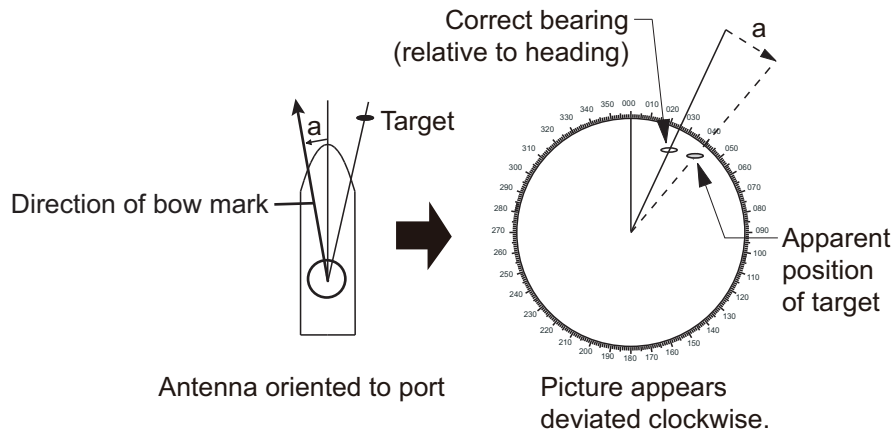

1. Set your radar between 0.125 and 0.25 NM range and the head up mode. You can select a range by using the pinch action. The range appears at the bottom right of the screen. Range may also be selected using the slide bar displayed on the right-hand side of the radar display area. Drag the bar up to zoom in, or down to zoom out.

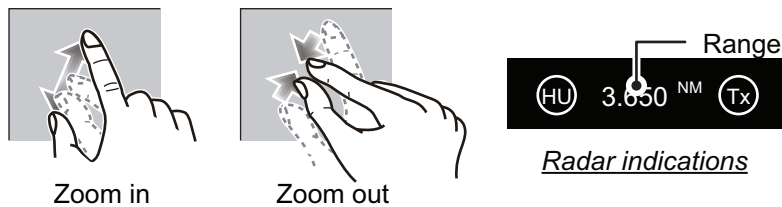

Pinch action

2. Turn the vessel's bow toward a target.
3. Tap the [Home] icon to show the home screen and display mode settings.
4. Tap [Radar] to show the [Radar] menu.
5. Drag the [Radar] menu to show the [RADAR INITIAL SETUP] menu.
6. Tap [Antenna Heading Align].
7. Key in the offset value so that the target is displayed at the very top of the screen (setting range: +179.9° to -180°, +: clockwise direction, -: counterclockwise direction), then tap the  icon.
8. Confirm that the target echo is displayed at correct bearing on the screen.

2.2.2 Initial setup for NavNet TZtouch (TZT9/TZT14/TZTBB)

1. Press the **Home** key (or tap the **Home** icon).
2. Select [Menu] on the menu icon bar to open the main menu.
3. Select [Radar].
4. Select [Radar Source] on the [Menu Radar] sub menus, then select the radar type connected.

Note: If a antenna unit is connected but does not appear in the [Radar Source] list, close the list and open it again. The name of the antenna unit should appear with a check mark, as in the example below.

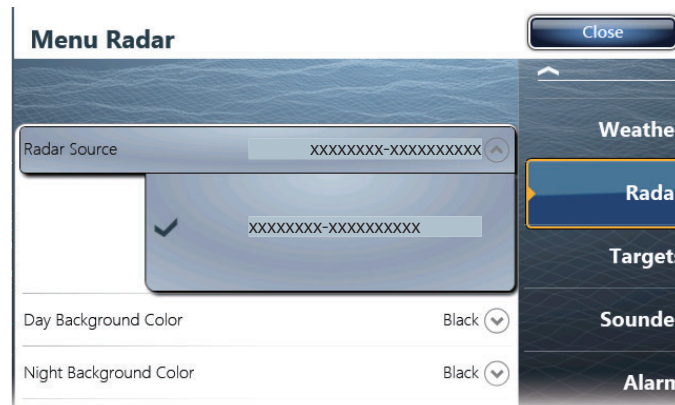

5. Drag the [Menu Radar] sub menus to find the menu item [Radar Initial Setup].

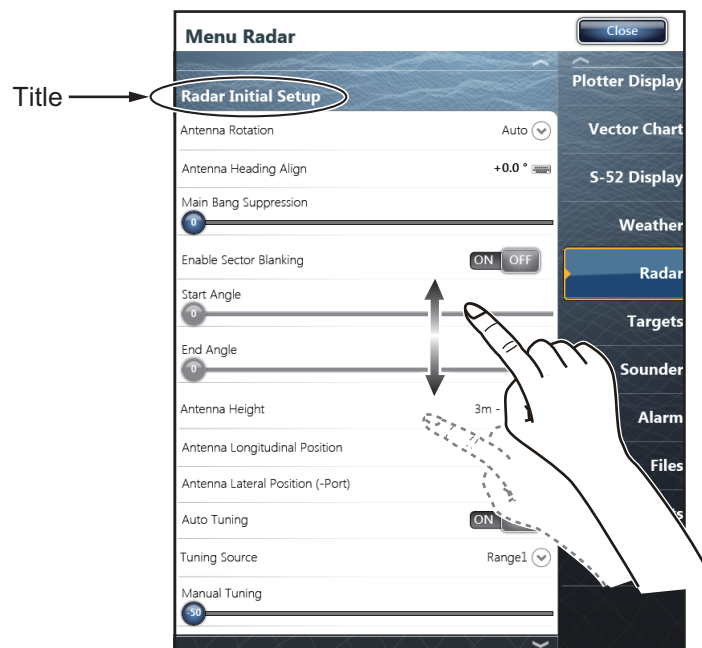

Menu Radar (Radar Initial Setup)

Menu item	Description
[Antenna Rotation]	Select the speed of antenna rotation.
[Antenna Heading Align]	See the topic of "How to align the antenna heading" on page 2-12.
[Main Bang Sup-pression]	If main bang appears at the screen center, slide the circle icon so that the main bang disappears, while watching the radar echo at the left-hand side of the display.

2. INITIAL SETUP

Menu item	Description
[Enable Sector Blanking]	Up to two sectors may be selected for blanking (no transmission). Select [ON] to enable this feature. Set the start and end angles (0° to 359°).
[Enable Sector 2 Blanking]	
[Antenna Height]	Select the height of the antenna above the waterline.
[Antenna Longitudinal Position]	Enter the antenna positioning bow-stern (Longitudinal) and port-starboard (lateral) position from the origin.
[Antenna Lateral Position (-Port)]	
[Radar Monitoring]	Display various information regarding the connected radar.
[ARPA Advanced Settings]	For service technician only. Do not change these settings. This menu item is available when setting the radar in transmit.
[TX Channel]	Select [1], [2] or [3], the channel where the interference is smallest.
[Target Analyzer Mode]	You can emphasize rain clutter or target echoes when the target analyzer is active. Select [Rain] or [Target] as appropriate.
[Auto acquire by Doppler]	When set to [ON], approaching targets (ships, rain clutter, etc.) within 3 NM from own ship are automatically acquired by the Doppler calculated from the radar echo.
[Hardware Factory Default]	Resets the radar selected at [Radar Source] to factory default.
[Reset Default Settings]	Resets the [Radar] menu settings to default.



How to align the antenna heading

You have mounted the antenna unit facing straight ahead in the direction of the bow. Therefore, a small but conspicuous target dead ahead visually should appear on the heading line (zero degrees).

In practice, you will probably observe some small bearing error on the display because of the difficulty in achieving accurate initial positioning of the antenna unit. The following adjustment will compensate for the error.

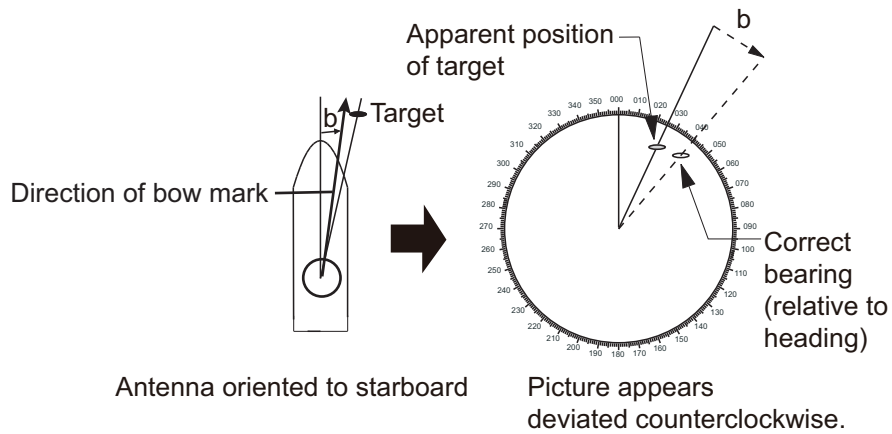
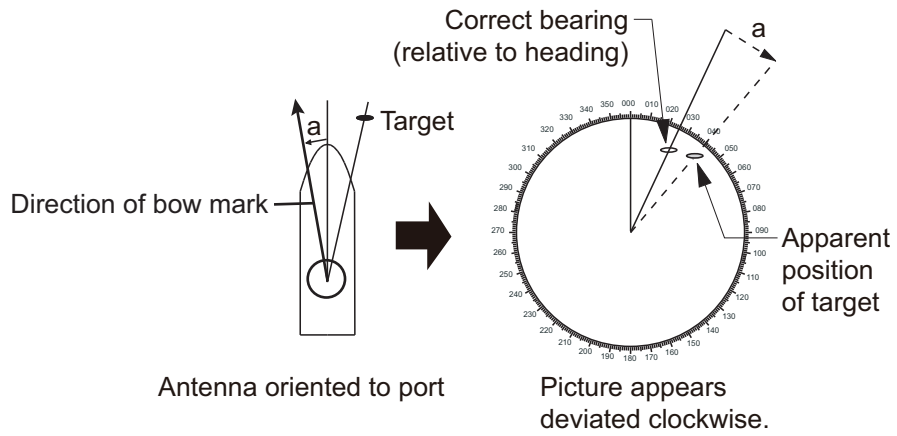

- 1) Select a range between 0.125 and 0.25 NM and set the mode to “head up”. You can select a range by a pinch action. The range and range ring interval appear at the bottom left of the screen.

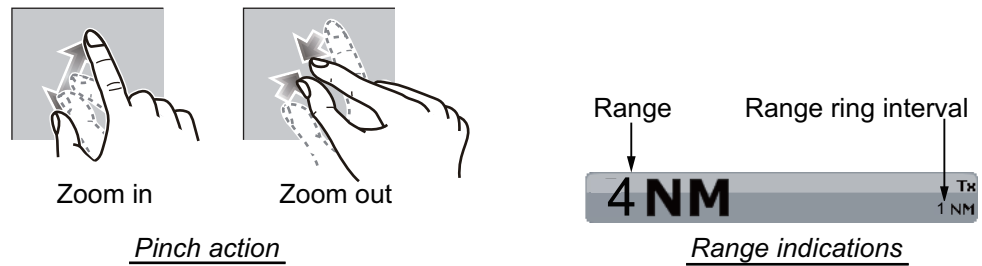

For TZTBB, you can also control the range in the operation as follows. Tap the radar scale box at the bottom left-hand corner of the screen to display the slider bar. Drag the circle icon to set the range scale.

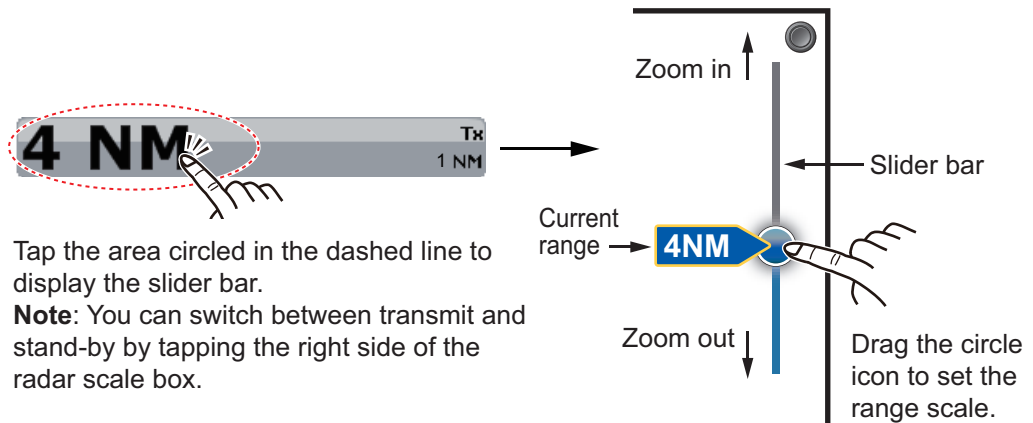

- 2) Turn the vessel's bow toward a target.

2. INITIAL SETUP

- 3) Press the **Home** key (or tap the **Home** icon), then select [Menu] icon, [Radar], and [Antenna Heading Align] in that order to show the numeric software keyboard.
- 4) Key in the offset value so that the target is at the very top of the screen (setting range: +/- 0° to 180°, +: clockwise direction, -: counterclockwise direction), then tap [Save].
- 5) Confirm that the target echo is displayed at correct bearing on the screen.

3. MAINTENANCE, TROUBLE-SHOOTING

WARNING



DO NOT OPEN THE SENSOR.
Electrical shock hazard

There are no user-serviceable parts inside. Only qualified personnel are allowed to work inside the equipment.

3.1 Maintenance

Regular maintenance is important for good performance. Check the points mentioned below every 3 to 6 months to keep the radar sensor in good working order. Observe the safety instructions at the front of this manual when working on the mast.

Check point	Action
Fixing bolts <ul style="list-style-type: none"> • Corrosion • If they are tightened 	<ul style="list-style-type: none"> • Replace corroded bolts. • Tighten loosened bolts. • Coat new bolts with marine sealant.
Radome <ul style="list-style-type: none"> • Cracks • Foreign material 	If a crack is found, repair it temporarily with a small amount of sealing compound or adhesive. Bring the unit to your dealer for permanent repairs. Foreign material on the radome can cause a considerable drop in sensitivity. Remove foreign material with a freshwater-moistened cloth. Do not use commercial cleaners to clean the sensor; they can remove paint and markings or deform the plastic.

3.2 Replacement of Fuse

The 5A fuse (Type: FRU-2P5S-FU-5A-A, Code No.: 000-168-869-10) in the fuse holder on the cable assembly protects the radar sensor from overcurrent and equipment fault. If you cannot turn on the power, check the fuse to see if it has blown. If the fuse has blown, find the reason before you replace the fuse. If the fuse blows again after the replacement, contact your dealer for advice.

WARNING



Use the proper fuse.
Use of a wrong fuse can cause fire or damage the equipment.

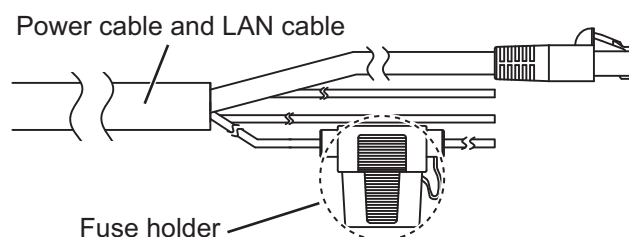

How to replace the fuse

Open the fuse holder cover and replace the fuse. Then close the cover.

3.3 Troubleshooting

The table below provides simple troubleshooting procedures to restore normal operation. If you cannot restore normal operation, contact your dealer for advice.

Trouble	Remedy
The radar type does not appear on the multi function display device.	<ul style="list-style-type: none"> • Check if the Cable Assembly is connected to the power source and the power source is on. • Check the power cable for damage. • Check if the fuse has blown. • Check the voltage of ship's main. • Check the software version of the multi function display device.
The radar type appears on the multi function display device, but the radar display does not appear or transmission does not start.	Check the software version of multi function display device.
The radar appears on the multi function display device, but disappears when the transmission started or continue rebooting.	Check the power voltage is sufficient.
Transmission starts, but echoes do not appear or weak echoes occur.	Check the settings of GAIN/SEA/RAIN.
Too much interference.	<ul style="list-style-type: none"> • Turn the interference rejector on. • Turn the transmission on/off. • Change the transmission channel.
Marks and characters appear on the display, but echoes do not appear.	Check that the Cable Assembly is fastened.
You changed the range, but the radar picture does not change.	<ul style="list-style-type: none"> • Try to zoom the radar display in or out. • Turn the power off and on.
Signal strength is too low.	Have a technician check the radar.

3.4 Life of Parts

Antenna Motor

When an antenna motor reaches the end of its life, the antenna's rotation may stop or abnormal noise sounds from the antenna unit. If such symptoms occur, contact your local dealer about replacement of the antenna motor.

Name	Type	Code No.	Approx. Life
Motor	RM-9794	001-031-140	2, 000 hours

APPENDIX 1 RADIO REGULATORY INFORMATION

USA-Federal Communications Commission (FCC)

This device complies with part 15 of the FCC Rules. Operation is subject to the following two conditions:

- (1) This device may not cause harmful interference, and
- (2) This device must accept any interference received, including interference that may cause undesired operation. Any changes or modifications not expressly approved by the party responsible for compliance could void the user's authority to operate the equipment.

Caution: Exposure to Radio Frequency Radiation

- This equipment complies with FCC radiation exposure limits set forth for an uncontrolled environment and meets the FCC radio frequency (RF) Exposure Guidelines in Supplement C to OET65.
- This equipment should be installed and operated keeping the radiator at least 70 cm or more away from person's body.
- This device must not be co-located or operating in conjunction with any other antenna or transmitter.

Canada-Industry Canada (IC)

Caution: Exposure to Radio Frequency Radiation

This equipment complies with IC radiation exposure limits set forth for an uncontrolled environment and meets RSS-102 of the IC radio frequency (RF) Exposure rules. This equipment should be installed and operated keeping the radiator at least 70 cm or more away from person's body.

Cet équipement est conforme aux limites d'exposition aux rayonnements énoncées pour un environnement non contrôlé et respecte les règles d'exposition aux fréquences radioélectriques (RF) CNR-102 de l'IC. Cet équipement doit être installé et utilisé en gardant une distance de 70 cm ou plus entre le dispositif rayonnant et le corps.

To reduce potential radio interference to other users, the antenna type and its gain should be so chosen that the equivalent isotropically radiated power (EIRP) is not more than that required for successful communication.

**SPECIFICATIONS OF RADAR SENSOR
DRS4D-NXT**

1 RADIATOR

- 1.1 Antenna type Patch array antenna
- 1.2 Antenna length 22-inch
- 1.3 Horizontal beam width 3.9° typical (-3dB)
RezBoost effective beam width* 2.0° to 3.9°
*: RezBoost provides better echo resolution, in a manner similar to adjusting the beam width.
- 1.4 Vertical beam width 25° (-3dB)
- 1.5 Sidelobe attenuation -24 dB
- 1.6 Rotation 24/36/48 rpm coupled with range or 24 rpm fixed (select)

2 RADAR FUNCTION

- 2.1 Tx frequency

Ch #	P0N (MHz)	Q0N (MHz)
1	9380	9400
2	9400	9420
3	9420	9440

- 2.2 Output power 25 W nominal (equivalent to 4kW magnetron radar)
- 2.3 Intermediate frequency 83.75/103.75 MHz
- 2.4 Range, Pulse length and Pulse Repetition Rate (PRR)

Range (NM)	Pulse length (μs) (non-modulated/modulated)	PRR (Hz approx.)
0.0625 to 0.5	0.08/5.0	1100
0.75 to 1	0.15/7.5	
1.5 to 2	0.3/11	
3 to 4	0.6/13	
6 to 12	1.2/15	
16 to 36	1.2/18	

- 2.5 Minimum range 20 m
- 2.6 Range resolution 20 m
- 2.7 Bearing accuracy ±1°
- 2.8 Warm-up time Null

3 INTERFACE

- 3.1 Number of port LAN: 1 port, Ethernet, 100Base-TX, RJ45
- 3.2 Data sentences IEC61162-1/2
Input GGA, GLL, GNS, HDG, HDM, HDT, RMA, RMC, THS, VHW, VTG

4 POWER SUPPLY

12-24 VDC: 2.5-1.3 A

5 ENVIRONMENTAL CONDITIONS

- 5.1 Ambient temperature -25°C to +55°C (storage: -30°C to +70°C)
- 5.2 Relative humidity 93% or less at +40°C
- 5.3 Degree of protection IP26
- 5.4 Vibration IEC 60945 Ed.4

6 UNIT COLOR



N9.5 (cover), PANTONE2945C (bottom)

PACKING LIST

03HR-X-9851 -0 1/1

DRS4D-NXT-J/E

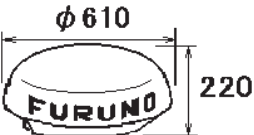
A-1

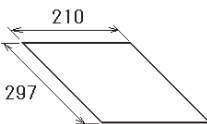
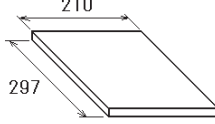
NAME	OUTLINE	DESCRIPTION/CODE No.	Q'TY
ユニット UNIT			
レーダーセンサー RADAR SENSOR		RSB-135-115 000-029-247-00	1
予備品 SPARE PARTS			
予備品 SPARE PARTS		SP03-18101 001-426-190-00	1
工事材料 INSTALLATION MATERIALS			
工事材料 INSTALLATION MATERIALS		CP03-37001 001-426-200-00	1
図書 DOCUMENT			
型紙 TEMPLATE		C32-00702-* 7/E1 000-167-458-1*	1
装備要領書 INSTALLATION MANUAL		IM*-36490-* 000-191-081-1* **	1

コード番号末尾の[**]は、選択品の代表コードを表します。



CODE NUMBER ENDING WITH "**" INDICATES THE CODE NUMBER OF REPRESENTATIVE MATERIAL.

(略図の寸法は、参考値です。 DIMENSIONS IN DRAWING FOR REFERENCE ONLY.)

C3649-Z01-A

FURUNO

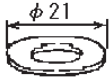
CODE NO.	001-426-200-00	03HR-X-9401 -0
TYPE	CP03-37001	1/1

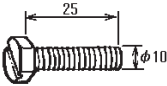
工事材料表 INSTALLATION MATERIALS					
番号 NO.	名称 NAME	略図 OUTLINE	型名/規格 DESCRIPTIONS	数量 Q'TY	用途/備考 REMARKS
1	ミガキ平座金 FLAT WASHER		M10 SUS304 CODE NO. 000-167-232-10	4	
2	ハネ座金 SPRING WASHER		M10 SUS304 CODE NO. 000-167-233-10	4	
3	六角スリワリボルト HEX. BOLT (SLOTTED HEAD)		M10X25 SUS304 CODE NO. 000-162-883-10	4	

(略図の寸法は、参考値です。 DIMENSIONS IN DRAWING FOR REFERENCE ONLY.)

FURUNO ELECTRIC CO., LTD.

C3649-M01-A

FURUNO

CODE NO.	001-426-190-00	03HR-X-9301-0 1/1
TYPE	SP03-18101	BOX NO. P

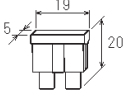
SHIP NO.	SPARE PARTS LIST FOR		U S E			SETS PER VESSEL	
ITEM NO.	NAME OF PART	OUTLINE	DWG. NO. OR TYPE NO.	QUANTITY			REMARKS/CODE NO.
				WORKING		SPARE	
				PER SET	PER VES		
1	ヒューズ FUSE		FRU-2P5S-FU-5A-B	1		1	000-168-869-10
MFR' S NAME	FURUNO ELECTRIC CO., LTD.		DWG NO.	03HR-X-9301		1/1	

(略図の寸法は、参考値です。 DIMENSIONS IN DRAWING FOR REFERENCE ONLY.)

表1 TABLE 1

寸法区分 (mm) DIMENSION	公差 (mm) TOLERANCE
$L \leq 50$	± 1.5
$50 < L \leq 100$	± 2.5
$100 < L \leq 500$	± 3
$500 < L \leq 1000$	± 4

取付穴 (有効ネジ深さ15)
4-M10
FIXING HOLES (THREAD DEPTH: 15)

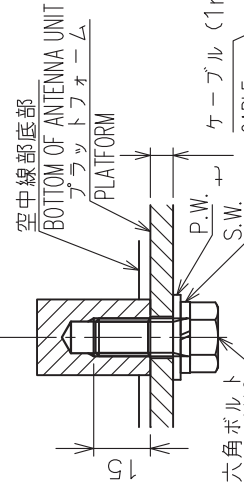
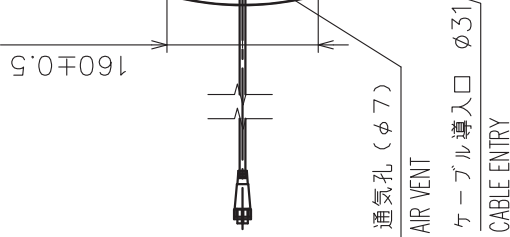
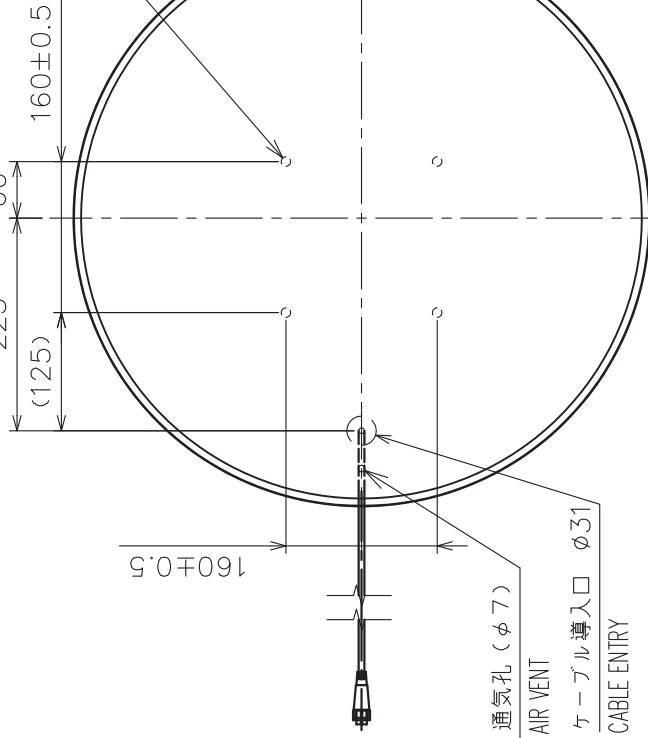

船首方向
BOW

型式銘板
NAMEPLATE
背面
REAR VIEW

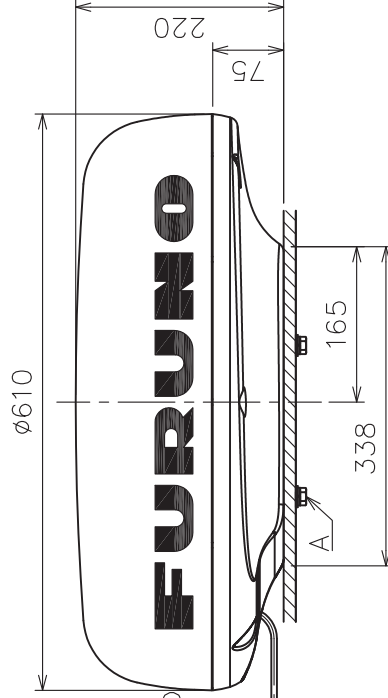
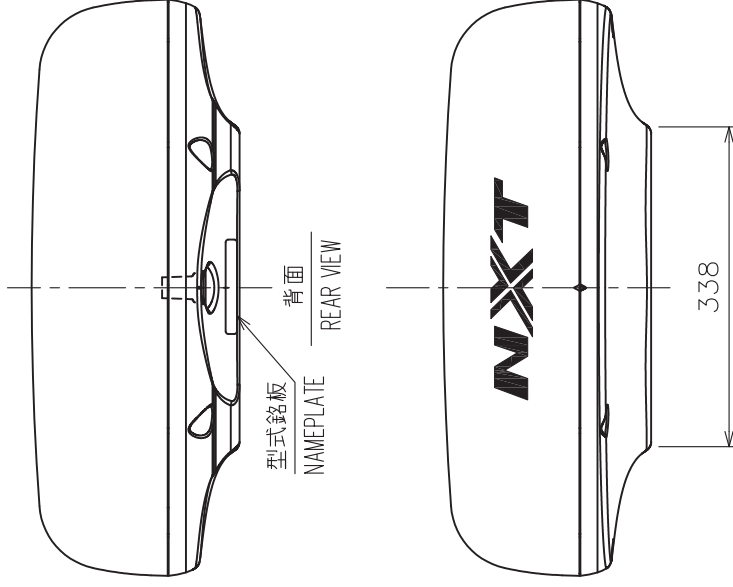

注 記

- 1) 指定外の寸法公差は表1による。
 - 2) 取付にはM10ボルトを使用のこと。
- 取付部ネジ深さ15mmにあったネジ長さを選定のこと。

NOTE

1. TABLE 1 INDICATES TOLERANCE OF DIMENSIONS WHICH IS NOT SPECIFIED.
 2. USE M10 BOLTS FOR FIXING THE UNIT.
- SELECT THREAD LENGTH ACCORDING TO THREAD DEPTH 15 mm.

DRAWN	15/Jun/2015	T.YAMASAKI	TITLE	DRS4D-NXT
CHECKED	15/Jun/2015	H.MAKI	名称	レーダーセンサー
APPROVED	17/Jun/2015	H.MAKI	外寸図	
SCALE	1/8	WSS 7.3 kg	NAME	RADAR SENSOR
DWG.No.	C3649-G01-A	REF.No.	03-187-300G-2	OUTLINE DRAWING

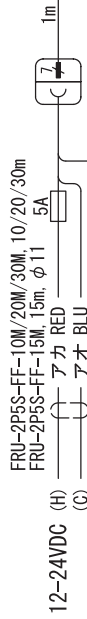
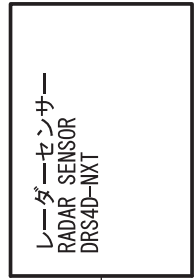

または OR
 マルチファンクションディスプレイ
 MULTI FUNCTION DISPLAY
 TZTL9/14/BB
 TZTL12F/15F

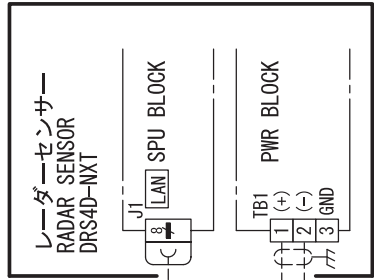

DRS4Dから換装時の接続
 CONNECTION FOR EXCHANGE
 FROM DRS4D

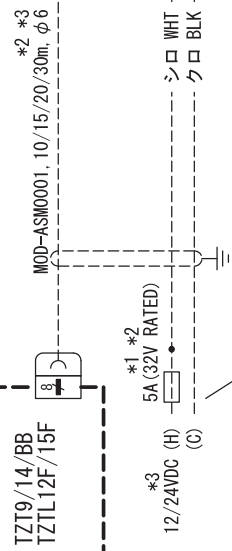

コネクタを取り外して芯線を電源につなぐ。
 CONNECT CORES TO DC POWER AFTER REMOVING THE PLUG.

注記

- * 1) 現地手配。
 - * 2) DRS4Dからの換装時。改造が必要。
 - * 3) 12V電源に対しては10mケーブルのみ可。
- NOTE
- *1: LOCAL SUPPLY.
 - *2: FOR EXCHANGE FROM DRS4D SERIES. MODIFICATION IS REQUIRED.
 - *3: 10m CABLE ONLY AVAILABLE FOR 12V SOURCE.

DRAWN	30/Jun/2015	T. YAMASAKI	TITLE	DRS4D-NXT
CHECKED	30/Jun/2015	H. MAKI	名称	レーダーセンサー
APPROVED	3/Jul/2015	H. MAKI		相互結線図
SCALE	MASS	kg	NAME	RADAR SENSOR
DWG. No.	C3649-C01-A		REF. No.	INTERCONNECTION DIAGRAM

FURUNO Worldwide Warranty for Pleasure Boats (Except North America)

This warranty is valid for products manufactured by Furuno Electric Co. (hereafter FURUNO) and installed on a pleasure boat. Any web based purchases that are imported into other countries by anyone other than a FURUNO certified dealer may not comply with local standards. FURUNO strongly recommends against importing these products from international websites as the imported product may not work correctly and may interfere with other electronic devices. The imported product may also be in breach of the local laws and mandated technical requirements. Products imported into other countries as described previously shall not be eligible for local warranty service.

For products purchased outside of your country please contact the national distributor of Furuno products in the country where purchased.

This warranty is in addition to the customer's statutory legal rights.

1. Terms and Conditions of Warranty

FURUNO guarantees that each new FURUNO product is the result of quality materials and workmanship. The warranty is valid for a period of 2 years (24 months) from the date of the invoice, or the date of commissioning of the product by the installing certified dealer.

2. FURUNO Standard Warranty

The FURUNO standard warranty covers spare parts and labour costs associated with a warranty claim, provided that the product is returned to a FURUNO national distributor by prepaid carrier.

The FURUNO standard warranty includes:

- Repair at a FURUNO national distributor
- All spare parts for the repair
- Cost for economical shipment to customer

3. FURUNO Onboard Warranty

If the product was installed/commissioned and registered by a certified FURUNO dealer, the customer has the right to the onboard warranty.

The FURUNO onboard warranty includes

- Free shipping of the necessary parts
- Labour: Normal working hours only
- Travel time: Up to a maximum of two (2) hours
- Travel distance: Up to a maximum of one hundred and sixty (160) KM by car for the complete journey

4. Warranty Registration

For the Standard Warranty - presentation of product with serial number (8 digits serial number, 1234-5678) is sufficient. Otherwise, the invoice with serial number, name and stamp of the dealer and date of purchase is shown.

For the Onboard Warranty your FURUNO certified dealer will take care of all registrations.

5. Warranty Claims

For the Standard Warranty - simply send the defective product together with the invoice to a FURUNO national distributor. For the Onboard Warranty – contact a FURUNO national distributor or a certified dealer. Give the product's serial number and describe the problem as accurately as possible.

Warranty repairs carried out by companies/persons other than a FURUNO national distributor or a certified dealer is not covered by this warranty.

6. Warranty Limitations

When a claim is made, FURUNO has a right to choose whether to repair the product or replace it.

The FURUNO warranty is only valid if the product was correctly installed and used. Therefore, it is necessary for the customer to comply with the instructions in the handbook. Problems which result from not complying with the instruction manual are not covered by the warranty.

FURUNO is not liable for any damage caused to the vessel by using a FURUNO product.

The following are excluded from this warranty:

- a. Second-hand product
- b. Underwater unit such as transducer and hull unit
- c. Routine maintenance, alignment and calibration services.
- d. Replacement of consumable parts such as fuses, lamps, recording papers, drive belts, cables, protective covers and batteries.
- e. Magnetron and MIC with more than 1000 transmitting hours or older than 12 months, whichever comes first.
- f. Costs associated with the replacement of a transducer (e.g. Crane, docking or diver etc.).
- g. Sea trial, test and evaluation or other demonstrations.
- h. Products repaired or altered by anyone other than the FURUNO national distributor or an authorized dealer.
- i. Products on which the serial number is altered, defaced or removed.
- j. Problems resulting from an accident, negligence, misuse, improper installation, vandalism or water penetration.
- k. Damage resulting from a force majeure or other natural catastrophe or calamity.
- l. Damage from shipping or transit.
- m. Software updates, except when deemed necessary and warrantable by FURUNO.
- n. Overtime, extra labour outside of normal hours such as weekend/holiday, and travel costs above the 160 KM allowance
- o. Operator familiarization and orientation.

FURUNO Electric Company, March 1, 2011

FURUNO Warranty for North America

FURUNO U.S.A., Limited Warranty provides a twenty-four (24) months LABOR and twenty-four (24) months PARTS warranty on products from the date of installation or purchase by the original owner. Products or components that are represented as being waterproof are guaranteed to be waterproof only for, and within the limits, of the warranty period stated above. The warranty start date may not exceed eighteen (18) months from the original date of purchase by dealer from Furuno USA and applies to new equipment installed and operated in accordance with Furuno USA's published instructions.

Magnetrons and Microwave devices will be warranted for a period of 12 months from date of original equipment installation.

Furuno U.S.A., Inc. warrants each new product to be of sound material and workmanship and through its authorized dealer will exchange any parts proven to be defective in material or workmanship under normal use at no charge for a period of 24 months from the date of installation or purchase.

Furuno U.S.A., Inc., through an authorized Furuno dealer will provide labor at no cost to replace defective parts, exclusive of routine maintenance or normal adjustments, for a period of 24 months from installation date provided the work is done by Furuno U.S.A., Inc. or an AUTHORIZED Furuno dealer during normal shop hours and within a radius of 50 miles of the shop location.

A suitable proof of purchase showing date of purchase, or installation certification must be available to Furuno U.S.A., Inc., or its authorized dealer at the time of request for warranty service.

This warranty is valid for installation of products manufactured by Furuno Electric Co. (hereafter FURUNO). Any purchases from brick and mortar or web-based resellers that are imported into other countries by anyone other than a FURUNO certified dealer, agent or subsidiary may not comply with local standards. FURUNO strongly recommends against importing these products from international websites or other resellers, as the imported product may not work correctly and may interfere with other electronic devices. The imported product may also be in breach of the local laws and mandated technical requirements. Products imported into other countries, as described previously, shall not be eligible for local warranty service.

For products purchased outside of your country please contact the national distributor of Furuno products in the country where purchased.

WARRANTY REGISTRATION AND INFORMATION

To register your product for warranty, as well as see the complete warranty guidelines and limitations, please visit www.furunousa.com and click on "Support". In order to expedite repairs, warranty service on Furuno equipment is provided through its authorized dealer network. If this is not possible or practical, please contact Furuno U.S.A., Inc. to arrange warranty service.

FURUNO U.S.A., INC.
Attention: Service Coordinator
4400 N.W. Pacific Rim Boulevard
Camas, WA 98607-9408
Telephone: (360) 834-9300
FAX: (360) 834-9400

Furuno U.S.A., Inc. is proud to supply you with the highest quality in Marine Electronics. We know you had several choices when making your selection of equipment, and from everyone at Furuno we thank you. Furuno takes great pride in customer service.

Declaration of Conformity

[DRS4D-NXT]

Bulgarian (BG)	<p>С настоящото Furuno Electric Co., Ltd. декларира, че гореспоменат тип радиосъоръжение е в съответствие с Директива 2014/53/ЕС. Цялостният текст на ЕС декларацията за съответствие може да се намери на следния интернет адрес:</p>
Spanish (ES)	<p>Por la presente, Furuno Electric Co., Ltd. declara que el tipo de equipo radioeléctrico arriba mencionado es conforme con la Directiva 2014/53/UE. El texto completo de la declaración UE de conformidad está disponible en la dirección Internet siguiente:</p>
Czech (CS)	<p>Tímto Furuno Electric Co., Ltd. prohlašuje, že výše zmíněné typ rádiového zařízení je v souladu se směrnicí 2014/53/EU. Úplné znění EU prohlášení o shodě je k dispozici na této internetové adrese:</p>
Danish (DA)	<p>Hermed erklærer Furuno Electric Co., Ltd., at ovennævnte radioudstyr er i overensstemmelse med direktiv 2014/53/EU. EU-overensstemmelseserklæringens fulde tekst kan findes på følgende internetadresse:</p>
German (DE)	<p>Hiermit erkläre die Furuno Electric Co., Ltd., dass der oben genannte Funkanlagentyp der Richtlinie 2014/53/EU entspricht. Der vollständige Text der EU-Konformitätserklärung ist unter der folgenden Internetadresse verfügbar:</p>
Estonian (ET)	<p>Käesolevaga deklareerib Furuno Electric Co., Ltd., et ülalmainitud raadioseadme tüüp vastab direktiivi 2014/53/EL nõuetele. ELi vastavusdeklaratsiooni täielik tekst on kättesaadav järgmisel internetiaadressil:</p>
Greek (EL)	<p>Με την παρούσα η Furuno Electric Co., Ltd., δηλώνει ότι ο προαναφερθέντας ραδιοεξοπλισμός πληροί την οδηγία 2014/53/ΕΕ. Το πλήρες κείμενο της δήλωσης συμμόρφωσης ΕΕ διατίθεται στην ακόλουθη ιστοσελίδα στο διαδίκτυο:</p>
English (EN)	<p>Hereby, Furuno Electric Co., Ltd. declares that the above-mentioned radio equipment type is in compliance with Directive 2014/53/EU. The full text of the EU declaration of conformity is available at the following internet address:</p>
French (FR)	<p>Le soussigné, Furuno Electric Co., Ltd., déclare que l'équipement radioélectrique du type mentionné ci-dessus est conforme à la directive 2014/53/UE. Le texte complet de la déclaration UE de conformité est disponible à l'adresse internet suivante:</p>
Croatian (HR)	<p>Furuno Electric Co., Ltd. ovime izjavljuje da je gore rečeno radijska oprema tipa u skladu s Direktivom 2014/53/EU. Cjeloviti tekst EU izjave o sukladnosti dostupan je na sljedećoj internetskoj adresi:</p>
Italian (IT)	<p>Il fabbricante, Furuno Electric Co., Ltd., dichiara che il tipo di apparecchiatura radio menzionato sopra è conforme alla direttiva 2014/53/UE. Il testo completo della dichiarazione di conformità UE è disponibile al seguente indirizzo Internet:</p>
Latvian (LV)	<p>Ar šo Furuno Electric Co., Ltd. deklarē, ka augstāk minēts radioiekārta atbilst Direktīvai 2014/53/ES. Pilns ES atbilstības deklarācijas teksts ir pieejams šādā interneta vietnē:</p>

Lithuanian (LT)	Aš, Furuno Electric Co., Ltd., patvirtinu, kad pirmiau minėta radijo įrenginių tipas atitinka Direktyvą 2014/53/ES. Visas ES atitikties deklaracijos tekstas prieinamas šiuo interneto adresu:
Hungarian (HU)	Furuno Electric Co., Ltd. igazolja, hogy fent említett típusú rádióberendezés megfelel a 2014/53/EU irányelvnek. Az EU-megfelelőségi nyilatkozat teljes szövege elérhető a következő internetes címen:
Maltese (MT)	B'dan, Furuno Electric Co., Ltd., niddikjara li msemmija hawn fuq-tip ta' tagħmir tar-radju huwa konformi mad-Direttiva 2014/53/UE. It-test kollu tad-dikjarazzjoni ta' konformità tal-UE huwa disponibbli f'dan l-indirizz tal-Internet li ġej:
Dutch (NL)	Hierbij verklaar ik, Furuno Electric Co., Ltd., dat het hierboven genoemde type radioapparaat conform is met Richtlijn 2014/53/EU. De volledige tekst van de EU-conformiteitsverklaring kan worden geraadpleegd op het volgende internetadres:
Polish (PL)	Furuno Electric Co., Ltd. niniejszym oświadcza, że wyżej wymieniony typ urządzenia radiowego jest zgodny z dyrektywą 2014/53/UE. Pełny tekst deklaracji zgodności UE jest dostępny pod następującym adresem internetowym:
Portuguese (PT)	O(a) abaixo assinado(a) Furuno Electric Co., Ltd. declara que o mencionado acima tipo de equipamento de rádio está em conformidade com a Diretiva 2014/53/UE. O texto integral da declaração de conformidade está disponível no seguinte endereço de Internet:
Romanian (RO)	Prin prezenta, Furuno Electric Co., Ltd. declară că menționat mai sus tipul de echipamente radio este în conformitate cu Directiva 2014/53/UE. Textul integral al declarației UE de conformitate este disponibil la următoarea adresă internet:
Slovak (SK)	Furuno Electric Co., Ltd. týmto vyhlasuje, že vyššie spomínané rádiové zariadenie typu je v súlade so smernicou 2014/53/EÚ. Úplné EÚ vyhlásenie o zhode je k dispozícii na tejto internetovej adrese:
Slovenian (SL)	Furuno Electric Co., Ltd. potrjuje, da je zgoraj omenjeno tip radijske opreme skladen z Direktivo 2014/53/EU. Celotno besedilo izjave EU o skladnosti je na voljo na naslednjem spletnem naslovu:
Finnish (FI)	Furuno Electric Co., Ltd. vakuuttaa, että yllä mainittu radiolaitetyyppi on direktiivin 2014/53/EU mukainen. EU-vaatimusten mukaisuusvakuutuksen täysimittainen teksti on saatavilla seuraavassa internetosoitteessa:
Swedish (SV)	Härmed försäkrar Furuno Electric Co., Ltd. att ovan nämnda typ av radioutrustning överensstämmer med direktiv 2014/53/EU. Den fullständiga texten till EU-försäkran om överensstämmelse finns på följande webbadress:

Online Resource

http://www.furuno.com/en/support/red_doc

ECF

(Elemental Chlorine Free)

The paper used in this manual
is elemental chlorine free.

FURUNO ELECTRIC CO., LTD.

9-52 Ashihara-cho,
Nishinomiya, 662-8580, JAPAN

• FURUNO Authorized Distributor/Dealer

All rights reserved. Printed in Japan

Pub. No. IME-36490-C

(ETMI) DRS4D-NXT

A : DEC. 2015

C : NOV. 22, 2017



0 0 0 1 9 1 0 8 2 1 2